

BCT2536

 MERIT SERIES B-VENT FIREPLACES













Our name is our promise.



TRADITIONAL

The BCT2536 offers excellent value without compromising on quality or design. This b-vent louvered design offers an array of standard features that include a dual tube burner, detailed ceramic fiber logs and fixed glass doors to provide continuous ambiance without additional heat to the room.

FEATURES

-  Available in 32" circulating rolled louvered model
-  Uses 4" b-vent
-  Millivolt (Remote-ready) or electronic ignition
-  Yellow flames with ember bed
-  Standard fixed tempered glass
-  Detailed ceramic fiber "split oak" log set with log grate
-  Black painted interior
-  Includes mesh fire screens
-  Durable textured powder coat finish
-  Optional outside air kit for increased performance
-  Optional blower and remote controls available for all models
-  20 year limited warranty

INTERIOR

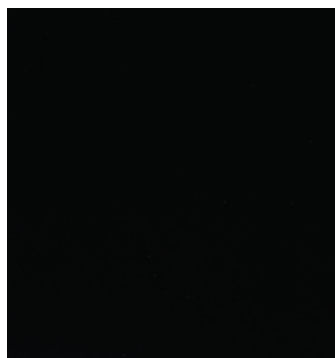

Black (painted)

APPLIANCE SPECIFICATIONS

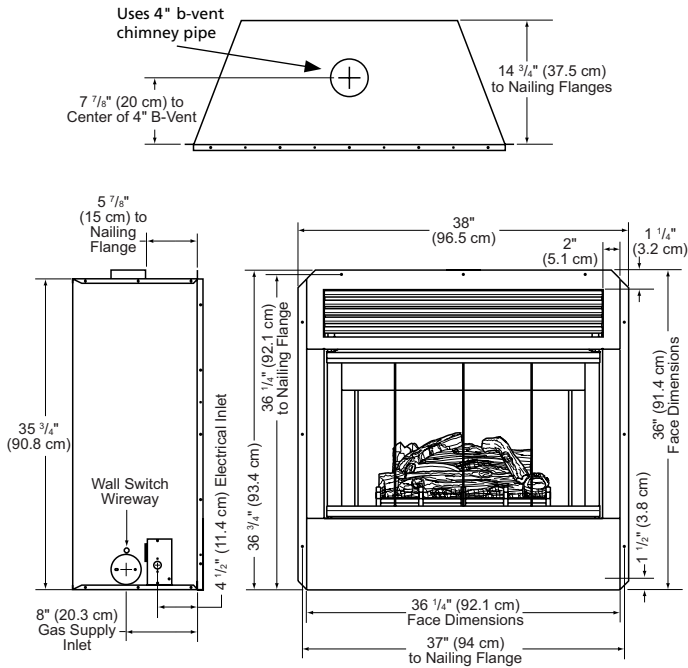

FRAMING SPECIFICATIONS

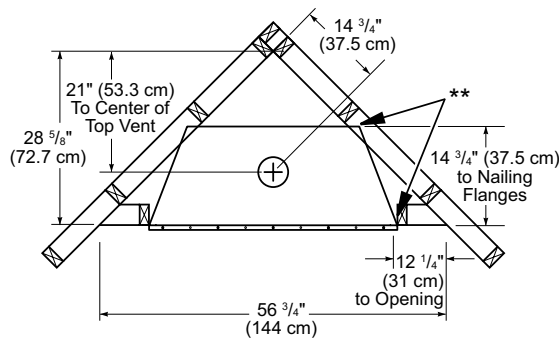

** These dimensions allow for 1" clearance at sides and back of fireplace. However, 0" clearance is also permitted at all sides when framed.

IMPORTANT NOTES:

As with any fireplace, this appliance is extremely hot during operation. Read and understand all operating instructions before using this appliance. For further information, consult your dealer.

Local conditions, such as elevation, wind, vent configuration and choice of fuel will affect overall appearance of the fire and heating performance. Performance can also vary with home design and insulation, climate, condition and type of fuel used, appliance location, burn rate, accessories chosen, chimney installation and how the appliance is operated.

Diagrams, illustrations and photographs are not to scale—consult installation instructions. Product designs, materials, dimensions, specifications, colors and prices are subject to change or discontinuance without notice.

OPTIONAL ACCESSORIES



Fixed Glass Doors (standard)



Black

ADDITIONAL ACCESSORIES

- A. Remote Controls
- B. Blower
- C. Outside Air Kit
- D. Perimeter Trim Kits

FIREPLACE BTU OPERATING INPUT

MODEL	FUEL	BTU/HR
BCT2536	NG	18,000
BCT2536	LP	18,000



© 2015 Innovative Hearth Products

785379M 06/15

Visit us online



SuperiorFireplaces.us.com

